

IEG1-31322-30

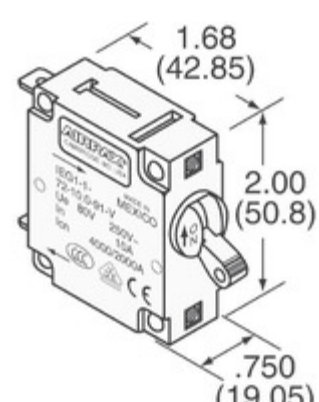

Obrázky jsou pouze orientační.
Podrobné informace o produktu naleznete v části Technické údaje produktu.

Koupit IEG1-31322-30 s důvěrou od Component-World.HK, 1 rok záruka



Part Number: [IEG1-31322-30](#)

Výrobce: [Sensata Technologies, Airpax](#)

Popis: CIR BRKR MAG-HYDR LEVER

Datový list: [IEG,IUG,JEG,CEG,LEG Series Datasheet](#)

RoHS Status: Bez olova / V souladu RoHS

Ship From: Hong Kong

Shipment Way: DHL/Fedex/TNT/UPS/EMS

[Request For Quotation](#)













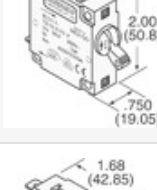
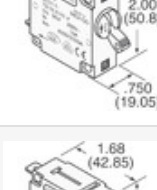
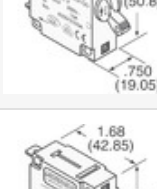
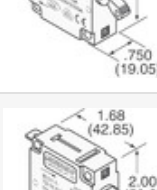
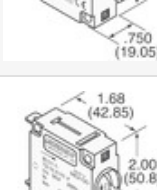

PARAMETR PRODUKTU

Part Number	IEG1-31322-30	Výrobce	Sensata Technologies, Airpax
Popis	CIR BRKR MAG-HYDR LEVER	Stav volného vedení / RoHS	Bez olova / V souladu RoHS
Dostupné množství	3622 pcs	Datový list	IAG,IUG,JEG,CEG,LEG Series Datasheet
Kategorie	Ochrana obvodu	Série	IEG
Počet pólů	1	Typ montáže	Panel Mount
Úroveň citlivosti na vlhkost (MSL)	1 (Unlimited)	Výrobní standardní doba výroby	6 Weeks
Stav volného vedení / RoHS	Lead free / RoHS Compliant	Osvětlení napětí (nominální)	-
Osvětlení	-	Jmenovitá hodnota proudu	-
Breaker Typ	Magnetic (Hydraulic Delay)	Pohon Type	Lever

Component-World.com je spolehlivý distributor elektronických součástek. Specializujeme se na všechny elektronické komponenty řady Sensata Technologies, Airpax. Máme 3622 kusy Sensata Technologies, Airpax IEG1-31322-30 na skladě dostupných. Vyžádejte si citát z distributora součástí elektroniky na Component-World.com, náš prodejní tým vás bude kontaktovat do 24 hodin.

RFQ Email: info@Components-World.com

SOUVISEJÍCÍ PRODUKTY

	Část#: IEG1-29628-1-V	Výrobci: Sensata Technologies, Airpax	Dotaz
	Část#: IEG1-30021-1-V	Výrobci: Sensata Technologies, Airpax	Dotaz
	Část#: IEG1-31724-8-V	Výrobci: Sensata Technologies, Airpax	Dotaz
	Část#: IEG1-31724-4-V	Výrobci: Sensata Technologies, Airpax	Dotaz
	Část#: IEG1-30651-1-V	Výrobci: Sensata Technologies, Airpax	Dotaz
	Část#: IEG1-30240-15-V	Výrobci: Sensata Technologies, Airpax	Dotaz
	Část#: IEG1-31322-15	Výrobci: Sensata Technologies, Airpax	Dotaz
	Část#: IEG1-32489-5-V	Výrobci: Sensata Technologies, Airpax	Dotaz
	Část#: IEG1-31724-5-V	Výrobci: Sensata Technologies, Airpax	Dotaz
	Část#: IEG1-31716-1-V	Výrobci: Sensata Technologies, Airpax	Dotaz
	Část#: IEG1-32752-1-V	Výrobci: Sensata Technologies, Airpax	Dotaz
	Část#: IEG1-30624-1-V	Výrobci: Sensata Technologies, Airpax	Dotaz
	Část#: IEG1-31322-5	Výrobci: Sensata Technologies, Airpax	Dotaz
	Část#: IEG1-30624-2-V	Výrobci: Sensata Technologies, Airpax	Dotaz
	Část#: IEG1-31724-6-V	Výrobci: Sensata Technologies, Airpax	Dotaz
	Část#: IEG1-31717-1-V	Výrobci: Sensata Technologies, Airpax	Dotaz
	Část#: IEG1-30624-4-V	Výrobci: Sensata Technologies, Airpax	Dotaz
	Část#: IEG1-30624-3-V	Výrobci: Sensata Technologies, Airpax	Dotaz
	Část#: IEG1-31724-7-V	Výrobci: Sensata Technologies, Airpax	Dotaz
	Část#: IEG1-29230-3-V	Výrobci: Sensata Technologies, Airpax	Dotaz

Související klíčová slova pro IEG1-31322-30

Sensata Technologies, Airpax IEG1-31322-30.	IEG1-31322-30 distributor	IEG1-31322-30 dodavatel	IEG1-31322-30 Cena
IEG1-31322-30 Stáhnout datasheet.	IEG1-31322-30 Datasheet.	IEG1-31322-30 Stock.	koupit IEG1-31322-30.
Sensata Technologies, Airpax IEG1-31322-30.	Sensata Technologies/Airpax IEG1-31322-30.		